

1 2 3 4 5 6 7 8

REV	LOCATIONS	DESCRIPTION	DATE	REVISER	APPD
1	△	Size changes	20/JUL/20	KATE	CHERRY

SPECIFICATIONS

Electrical
 Current Rating: 2.0A AC(rms)/DC
 Voltage Rating: 250V AC(rms)/DC
 Contact Resistance: 20 mΩ Max
 Insulation Resistance: 1000 MΩ Min
 Withstanding Voltage: 500V AC r.m.s
 Temperature Range-Operating: -40°C~+85°C

Material and Plating
 Housing: PA6T (UL 94V-0)
 Pin: Brass/ Gold plated

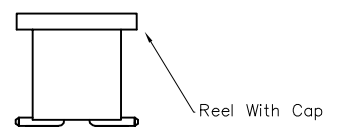
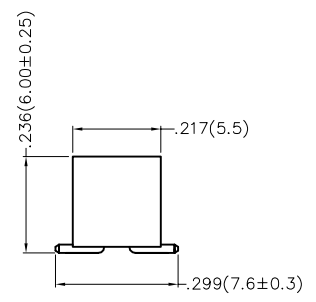
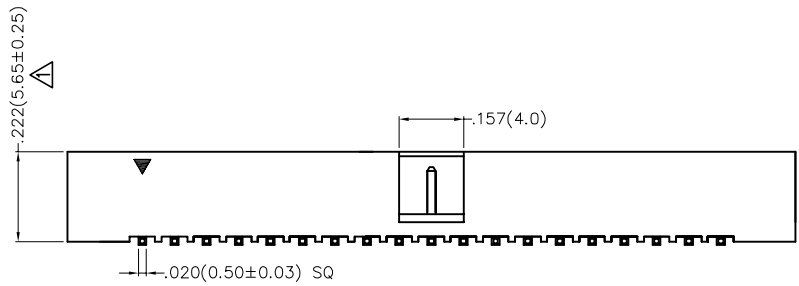
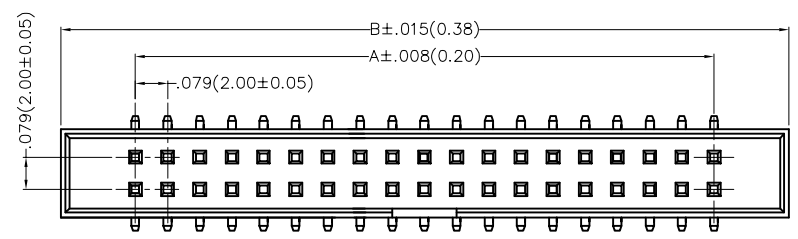

Ordering Information

FBH 200 22 - D XX S 1 XX 4 K6 X
 1 2 3 4 5 6 7 8 9 10 11

1 Category FBH-Box Header	2 Series Number 200-Pitch2.00mm	3 Distinction No. 22	4 Contact Alignment D-Double Row	5 Circuits XX	
6 Entry Angle S-180° Vertical	7 Plating 1-Gold plated	8 Thickness of Plating 00-Gold Flash 01-1μ" Custom plate available	9 Material-Resin 4-PA6T	10 Color-Resin K6-Black	11 Packaging K-Tray M-Reel

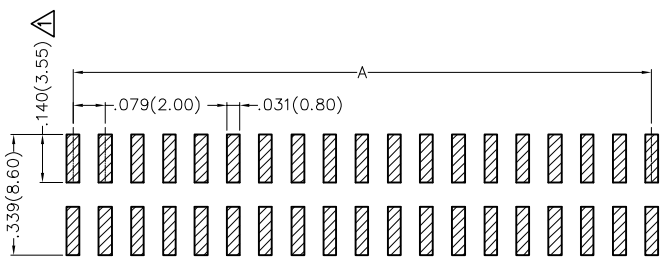

Recommended P.C.Board Layout

THIRD ANGLE PROJECTION	GENERAL TOLERANCES (UNLESS SPECIFIED)		APPROVE BY FRANK	DATE 19/JUL/13	PART NO. FBH20022-DXXS1XX4K6X	ITEM NO. FBH20022	 Building Technology Cornerstone
	DESIGN UNITS Inch (metric)	X.±.012(0.30) X.X±.008(0.20)	X'.±5' .X'±2'	CHECKED BY CHERRY	DATE 19/JUL/13	TITLE Wire to Board(Box Header) Pitch 2mm Vertical 180°(SMT)	
SCALE 5:1	SIZE A4	X.XX±.006(0.15) X.XXX±.004(0.10)	.XX'±1' .XXX'±0.5'	DRAWN BY KATE	DATE 19/JUL/13	THIS DRAWING CONTAINS INFORMATION THAT IS PROPRIETARY TO TXGA INDUSTRIAL ELECTRONICS(S.Z)CO.,LTD AND SHOULD NOT BE USED WITHOUT WRITTEN PERMISSION	
						REV 1	SHEET NO. 1/2

1 2 3 4 5 6 7 8



1 2 3 4 5 6 7 8

REV	LOCATIONS	DESCRIPTION	DATE	REVISER	APPD

A
B
C
D
E
F

A
B
C
D
E
F

Circuits (n)	Part No.	Dimensions(in/mm)	
		A	B
6	FBH20022-D06S1XX4K6X	.157(4.00)	.524(13.30)
8	FBH20022-D08S1XX4K6X	.236(6.00)	.602(15.30)
10	FBH20022-D10S1XX4K6X	.315(8.00)	.681(17.30)
14	FBH20022-D14S1XX4K6X	.472(12.00)	.839(21.30)
16	FBH20022-D16S1XX4K6X	.551(14.00)	.917(23.30)
20	FBH20022-D20S1XX4K6X	.709(18.00)	1.075(27.30)
24	FBH20022-D24S1XX4K6X	.866(22.00)	1.232(31.30)
26	FBH20022-D26S1XX4K6X	.945(24.00)	1.311(33.30)
28	FBH20022-D28S1XX4K6X	1.024(26.00)	1.390(35.30)
30	FBH20022-D30S1XX4K6X	1.102(28.00)	1.469(37.30)
34	FBH20022-D34S1XX4K6X	1.260(32.00)	1.626(41.30)
36	FBH20022-D36S1XX4K6X	1.339(34.00)	1.705(43.30)
40	FBH20022-D40S1XX4K6X	1.496(38.00)	1.862(47.30)
44	FBH20022-D44S1XX4K6X	1.654(42.00)	2.020(51.30)
50	FBH20022-D50S1XX4K6X	1.890(48.00)	2.256(57.30)
64	FBH20022-D64S1XX4K6X	2.441(62.00)	2.807(71.30)
68	FBH20022-D68S1XX4K6X	2.598(66.00)	2.965(75.30)

 THIRD ANGLE PROJECTION	GENERAL TOLERANCES (UNLESS SPECIFIED)		APPROVE BY FRANK	DATE 19/JUL/13	PART NO. FBH20022-DXXS1XX4K6X	ITEM NO. FBH20022	 Leader Of Industry	
	DESIGN UNITS Inch (metric)	X.±.012(0.30) X.X±.008(0.20) X.XX±.006(0.15) X.XXX±.004(0.10)	X.±5° .X'±2° .XX'±1° .XXX'±0.5°	CHECKED BY CHERRY	DATE 19/JUL/13	TITLE Wire to Board(Box Header) Pitch 2mm Vertical 180°(SMT)		
SCALE 5:1	SIZE A4		DRAWN BY KATE	DATE 19/JUL/13	THIS DRAWING CONTAINS INFORMATION THAT IS PROPRIETARY TO TXGA INDUSTRIAL ELECTRONICS(S.Z)CO.,LTD AND SHOULD NOT BE USED WITHOUT WRITTEN PERMISSION		REV 1	SHEET NO. 2/2

1 2 3 4 5 6 7 8